



150W LINEAR HIGHBAY LIGHT

LIGHT THE WORLD



ITEM No.: MLL-L150-3

Electrical Specifications

- **Led Power** 150w
- **IP Grade** IP42
- **Input Voltage** AC 100-277V(50/60Hz)
- **Operating Temperature** -30°C to +45°C
- **Driver Brand** PHILIPS or MOSO
- **Power Factor (PF)** >0.95
- **Protection class IK** IK09
- **Certification** CE,ROHS,SAA



Photometric & Packing Specifications

Led Lamp	SMD 3030 LED
Lumen Output	>15000lm
Light Efficiency	100lm/w
Sensor	Motion sensor optional
CCT	2700k~6500k
CRI	>80
Beam angle	120°

• Guarantee	5 years
• PC cover	Frosted + Honeycomb
• Material	Aluminum + anti-glare cover
• Mounting	Bracket & Hanging
• NW./GW.	3.4kg / 3.7kg
• Product size	200*1200mm
• Carton size	125*50*27cm, 4pcs/CTN

Product size(unit:mm)

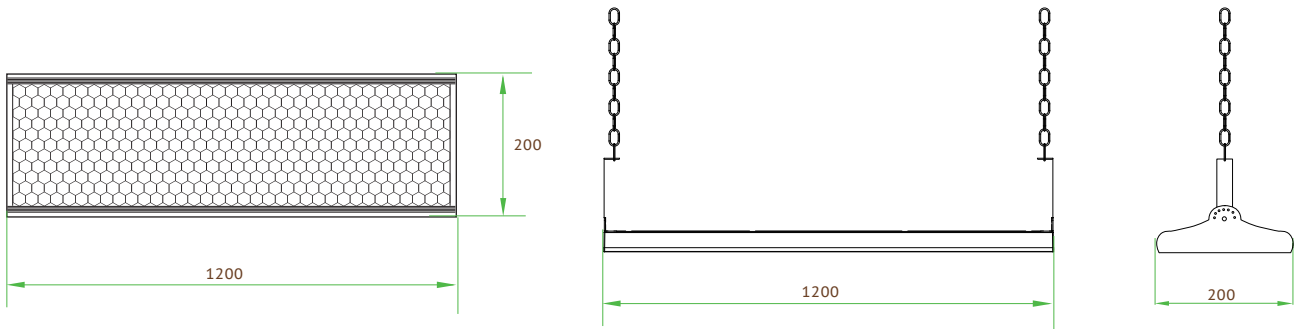

Application

Commercial Lighting: Supermarket, Exhibition hall, Parking place, Etc.

Public Lighting: Tunnel, MTR station, Train station, Bus station, Airport, Etc.

Industrial Lighting: Factory/Warehouse, Etc.

Wiring diagram

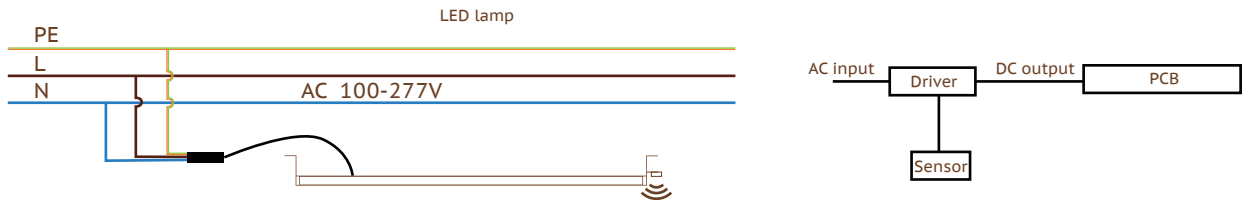

Steps dimming control demonstration

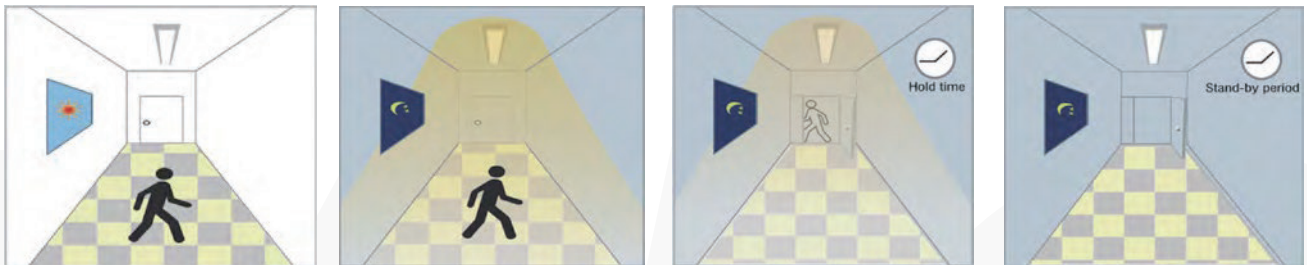

With sufficient daylight, even when motion detected, light remains OFF.

With insufficient daylight, when motion detected, light ON.

After last detection, the light will be dimmed down to the stand-by dimming level (10%,20%,30% or 50%) after holdtime.

After last stand-by period, light OFF.

Installation

A. Suspending

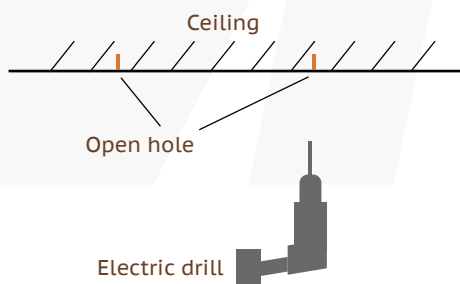

A. Make a right position and screw hole

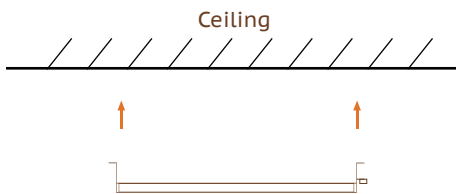

C. Hung the fixture under the steel cable and secure the fixture by steel cable

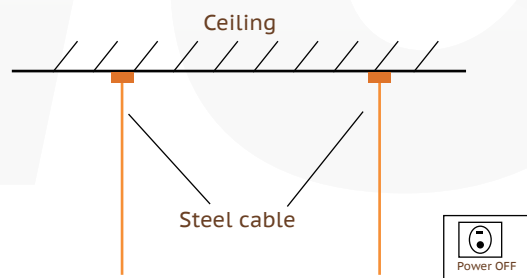

B. Screw the steel cable onto the ceiling

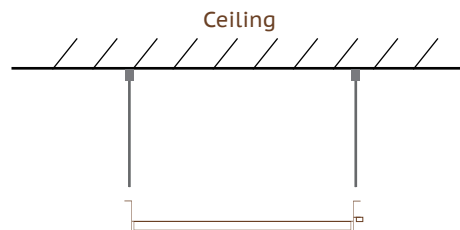

PLS note: PLS put the terminal of power cable into water proof box and use a listed water proof bushing when you link the power

D. Adjust the position of the fixture and clean it.





LINEAR Highbay Light

LIGHT THE WORLD

B. Ceiling mounted

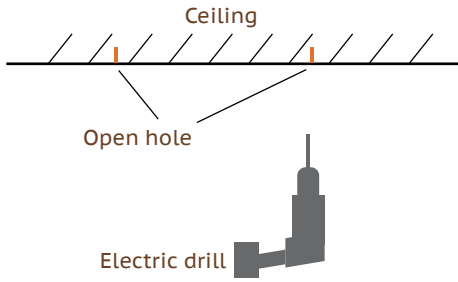

A. Make a right position and screw hole

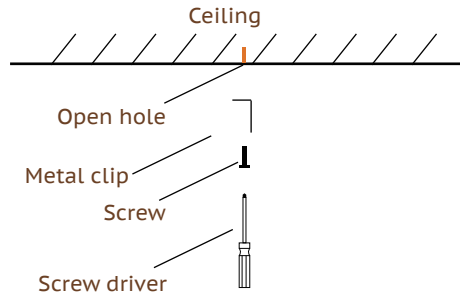

B. Screw the clip on the ceiling lightly

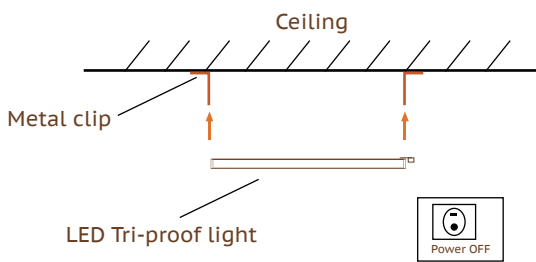

C. Install the lamp into the clips.

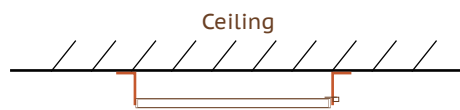

Note: Pls put the terminal of power cable into water proof box and use a listed water proof bushing when you link the power



D. Adjust the position of the fixture and clean it.

Pls note: Above installation "B" belongs to our standard installation, if you want to choose our way of "A" installation then you need to select our optional accessories and pay.

	Metal Card
	One package two pcs
Standard accessories	

	Remote control		Steel cable
	One pcs		One package two pcs
Optional accessories			

Matters needing attention

1. Before installing the lighting fixtures, please read this instruction manual carefully.
2. The lighting fixtures should be installed, connected and tested by a certified installer based on the local regulations.
3. Consulting the competent electrician if you have any uncertainty about the installation or the use of the product.
4. Lamps should always be installed or replaced with care.
5. Please check the local voltage in accordance with the product requirements before using the product.
6. Do not impact the lighting fixture and all its components by any external weight or mechanical force.
7. Due to the improperly using, or other any man-made damages to the LED light are our responsibility.