



MIC 80W LED STREET LIGHT

LIGHT THE WORLD



ITEM No.: MSL-S80-1

Electrical Specifications

• Led Power	80w
• IP Grade	IP66
• IK	IK09
• Input Voltage	85-305Vac
• Operating Temperature	-40°C to +50°C
• Driver Brand	Meanwell or Moso  
• Power Factor (PF)	>0.95
• Sensor	Photocell (optional)
• Certification	CE,ROHS,TUV,ETL

Photometric & Packing Specifications

• Led Lamp	SMD 3030 	• Guarantee	5 years
• Lumen Output	>10400LM	• CCT	2700k~6500k
• Light Efficiency	130lm/w	• Fitment Baser	Slip fitter
• Led Quantity	96pcs LEDs	• Material	Aluminum+Glass+Optical Lens
• Beam Angle	Type (2, 3, 4, 5)	• NW/GW	3kg/3.37kg
• Life span	>50000 hours	• Product size	545*200*84mm
• CRI	>80	• Carton size	585*235*125mm, 1pcs/CTN

Product size(Unit:mm)

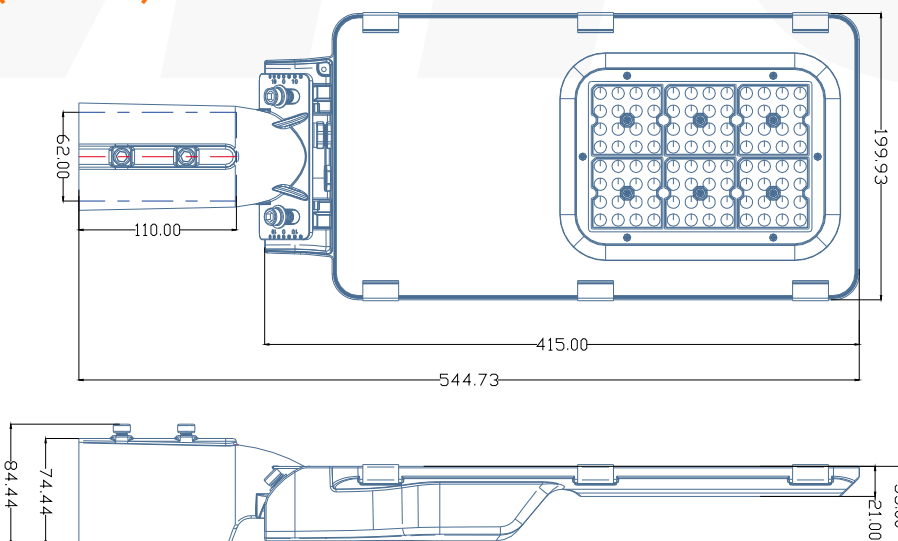

Gradienter

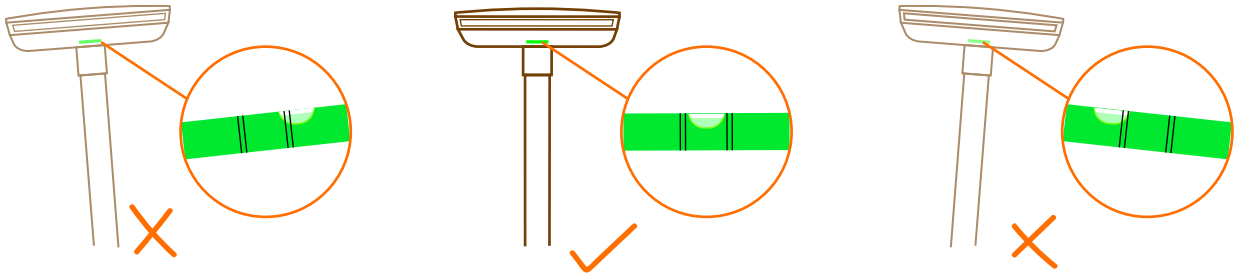

Exploded view

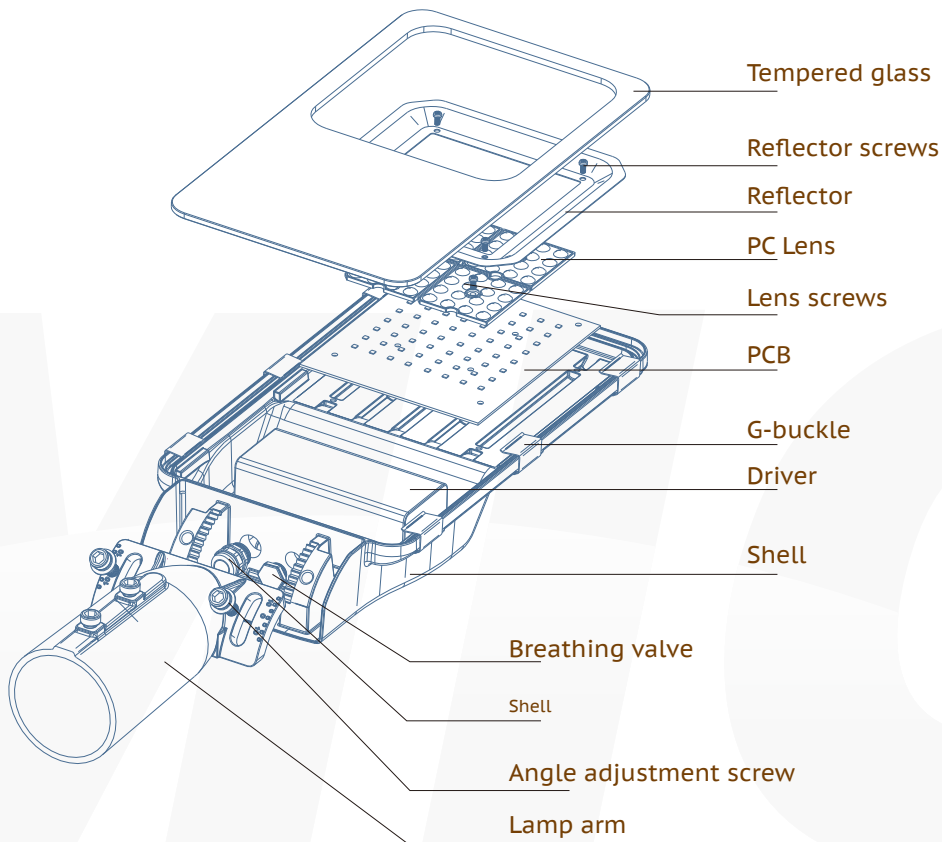

Application



INTERCHANGE



ROADS & MOTORWAYS



URBAN & RESIDENTIAL STREETS

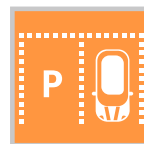

CAR PARKS



BIKE & PEDESTRIAN PATHS



HIGHMAST LIGHTING



SECURITY LIGHTING



INDUSTRIAL HARBOUR



LOADING BAY



SQUARES & PEDESTRIAN AREAS