

MIC 75W LED GARDEN LIGHT

LIGHT THE WORLD



ITEM No.: MYL-A75-3

Electrical Specifications

• Led Power	75w
• IP Grade	IP66
• IK	IK08
• Input Voltage	AC85-305V
• Operating Temperature	-40°C to +55°C
• Driver Brand	Meanwell Driver 
• Power Factor (PF)	>0.95
• Certification	CE,ROHS,TUV,FCC,ETL/DLC

Photometric & Packing Specifications

• Led Lamp	SMD 3030 PHILIPS	• Guarantee	6 years
• Led Quantity	100pcs LEDs	• CCT	2700k~6500k
• Lumen Output	>8250LM	• CRI	>80
• Light Efficient	110lm/w	• NW/GW	6.2kg/7.2kg
• Life span	>50000 hours	• Product size	466*445*480mm
• Beam angle	120°	• Carton size	550*515*515mm

Product size(Unit:mm)

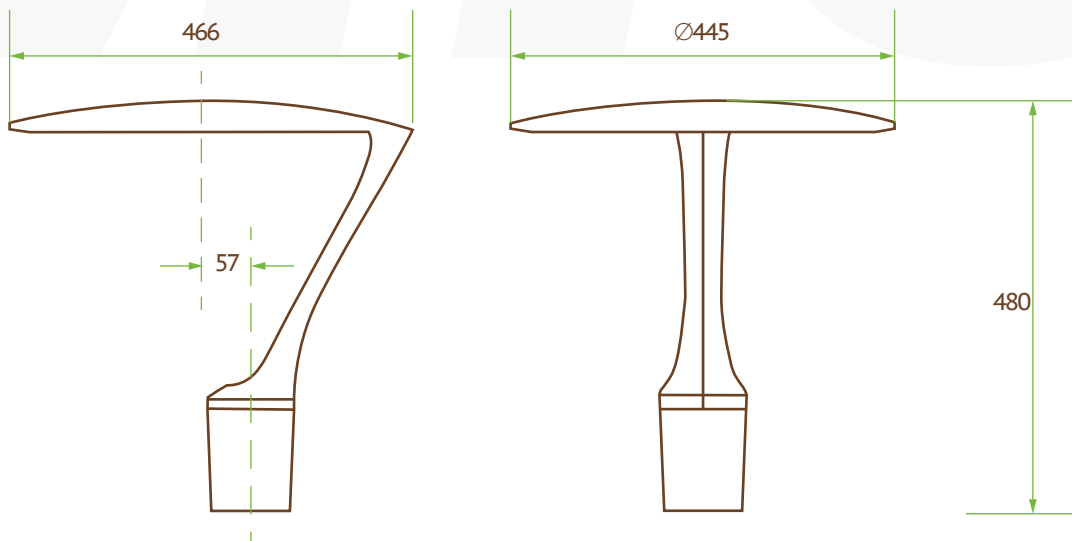

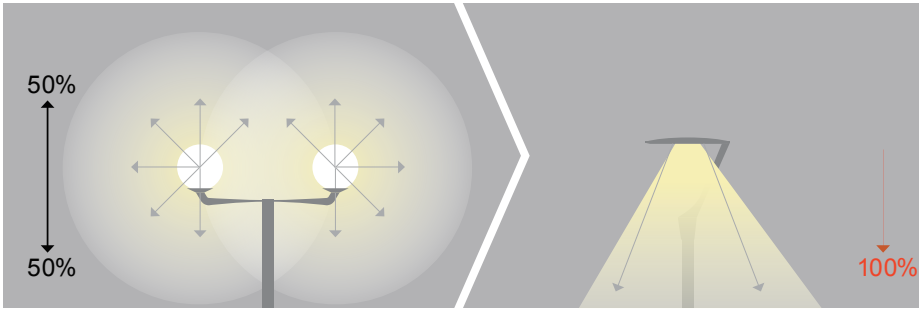

Energy Saving	75%
Light Pollution	0%
Life time	>50.000 h
On-off	immediately
Warranty	5 years

Impatto ambientale ridotto

La sostituzione di vecchi punti luce a lampada con i prodotti della linea MIC consente un elevato risparmio energetico e una riduzione dell'inquinamento luminoso. (Cut -Off)

Reduced environmental impact

The replacement of old light points lamp with the products of the MIC line allows high energy savings and a reduction in pollution bright. (Cut -Off)

Reduzierte Umweltbelastung

Die Auswechslung alter Glühbirnen-Lichtpunkte mit den Produkten der MIC-Produktreihe ermöglicht eine hohe Energieeinsparung und eine Verringerung der Lichtverschmutzung. (Cut -Off)

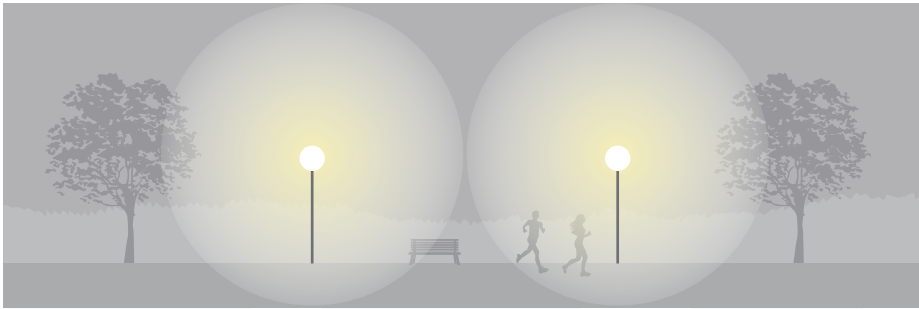

H: Post height post height
 H1: Height of the light source Height of the light source mounting height
 D: Interdistance distance
 I / H: interdistance / height ratio
 Distance / height ratio
 La: Street width Street width Street width
 Emed: Medium illumination Medium illumination
 Central lighting
 Emin: Minimum illumination Minimum illumination
 Minimum illuminance
 W: Total power consumption total power
 System performance
 STR: street optic street optic street optic
 RED: Rotosymmetrical

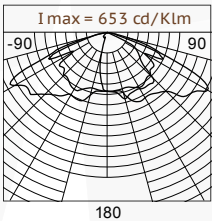

	H	H1	D	I/H	La	Emed	Emin	W
UNI 11248 (p2)				10	3			
MIC 12 525 LED STR ST-01	4	4.6	22.5	5.6	3	137	4.94	20
CERVIA 125W QE	4	4.6	22.5	5.6	3	8	3	138

Energy saving 10LED 20W vs QE 125W 138W -83%

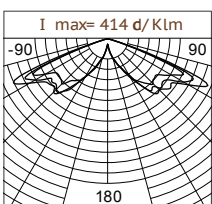
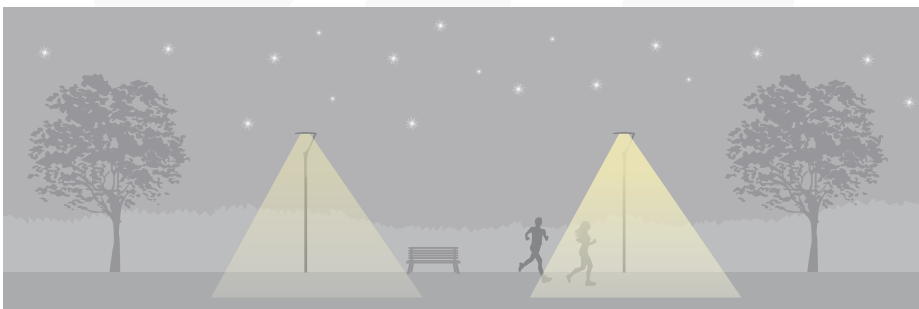

	H	H1	E Medio	U0	W
80W QE	4	4.6	6	0.28	88
125W QE	4	4.6	10	0.28	138
100W SE	4	4.6	17	0.28	115
MIC 12 350 LED ROT	4	4.6	7,5	0.34	14.5
MIC 12 700 LED ROT	4	4.6	11	0.34	28

Energy saving 12LED 14.5W vs QE 88W 88W -83%
Energy saving 12LED 28W vs QE 125W 138W -66%