



MIC 100W LED STREET LIGHT

LIGHT THE WORLD



ITEM No.: MSL-D100-1

Electrical Specifications

- **Led Power** 100w
- **IP Grade** IP66
- **Input Voltage** AC 85-305V
- **Operating Temperature** -35°C to +55°C
- **Driver Brand** UL driver  
- **Power Factor (PF)** >0.95
- **Protection class IK** IK08
- **Certification** ETL, DLC, CE, ROHS, TUV, CB, IECEE, SABER

Photometric & Packing Specifications

- **Led Lamp** SMD 5050 
- **Led Quantity** 64pcs LEDs
- **Lumen Output** >17000LM
- **Light Efficiency** 170lm/w
- **Photometric Type** TYPE II, TYPE III, TYPE IV
- **Life span** >50000 hours
- **CRI** >70
- **Guarantee** 6 years (meanwell) & 5 years (sosen)
- **CCT** 2700k~6500k
- **Material** Die-casting Aluminum+PC
- **Fitment Baser** Slip fitter
- **NW/GW** 6.5kg/7.5kg
- **Product size** 508*291*94mm
- **Carton size** 562*345*145mm, 1pcs/CTN

Installation method

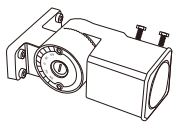

Slip Fitter

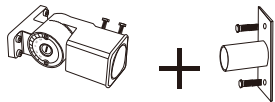

Adapter

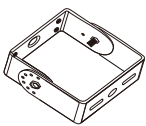

Trunion

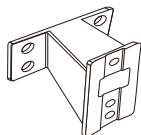

Arm



Dia50-60

Product size

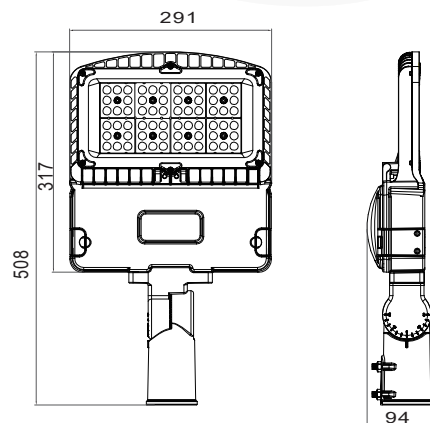

Photocell Sensor Optional

Automatically switches a light on at dusk and off at dawn.

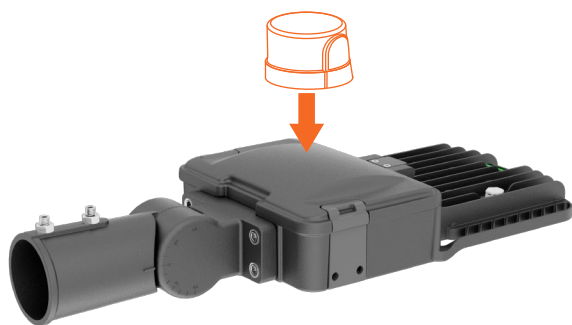

wiring scheme

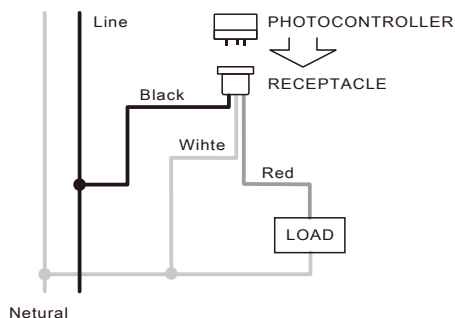

Disconnect power; wire the receptacle according to the diagram in right hand, Push the photocontroller on and twist it clockwise to lock it into the receptacle.

Model	JL-205C	Power Consumption	1.5VA
Rated Voltage	110-277VAC	On/Off Level	6Lx On, 50Lx Off
Rated Frequency	50/60Hz	Ambient Temp	-40 C~+70 C
Rated Loading	1000W Tungsten, 1800VA Ballast	Related Humidity	99%

Microwave Motion Sensor Optional

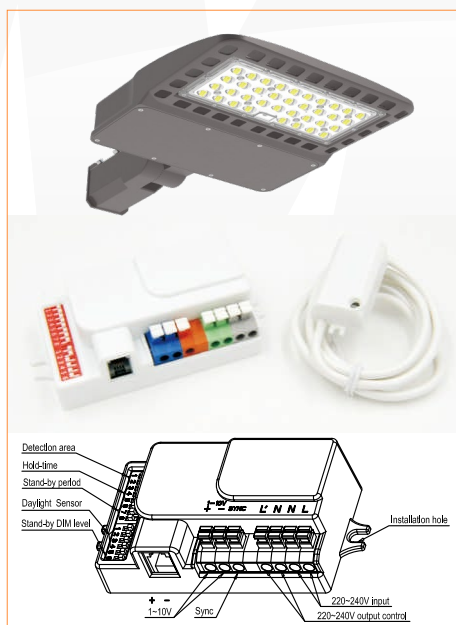

Detection Pattern

Operating voltage	120-277Vac, 50/60Hz
Rated load	400W @120Vac, 800W@220-277Vac(inductive)
HF system	5.8GHz±75MHz, ISM wave band
Transmitting power	<0.5mW
Power consumption	<1W(standby)
Detection zone	8m(@3m mounting height)
Detection sensitivity	25% / 50% / 75% / 100%
Hold time	5s / 30s / 90s / 3min / 20min / +∞
Daylight sensor	5 / 15 / 30 / 50 / 100 / 150 / Disable(lux)
Stand-by period	0s / 5s / 5min / 10min / 30min / 1h / +∞
Stand-by dimming level	10% / 20% / 30% / 50%
Mounting height	10m Max
Motion detection	0.5~3m/s
Operating temperature	-20°C ~ 60°C
Detection angle	150°(wall installation), 360°(ceiling installation)

Led shoebox light could connect with Microwave Motion Sensor, function requirements of detection area, time delay and daylight threshold can be precisely set via DIP switch.

MC605V/D is an innovative and active motion detectors with HF system 5.8GHz.

Dimming Function

Safety rope

1. Pass the ends of the safety rope through the hole in the lamp body and lock it with Wire rope clip.
2. Move the other end of the safety rope around the lamppost and lock it with a wire rope. (attach the other end of the safety rope to the expansion bolt on the wall.)



Wire rope dip/ din741: A=M3



Safety rope: 59.0"(1.5m)

Installation steps

Step 1: Make the following electrical connections:

- a. Connect INPUT GROUND conductor to GREEN WIRE position of the terminal block or GROUND conductor of LED driver.
- b. Connect INPUT VOLTAGE conductor to BROWN WIRE position of the terminal block or LINE conductor of LED driver.
- c. Connect INPUT NEUTRAL conductor to BLUE WIRE position of the terminal block or NEUTRAL conductor of LED driver.

STEP 2: Make sure all excess input wires are pushed into pole, screws are tightened.

STEP 3: Close cover by firmly pushing cover towards fixture, making sure that no wires are pinched and Sealing gasket are fully engaged.

STEP 4: IF the fixture without a terminal block, please insulate all electrical connections with wire nuts suitable for at least 90 C.

STEP 5: After installation , sealed by waterproof glue between fixture and pole.

1.Slip Fitter

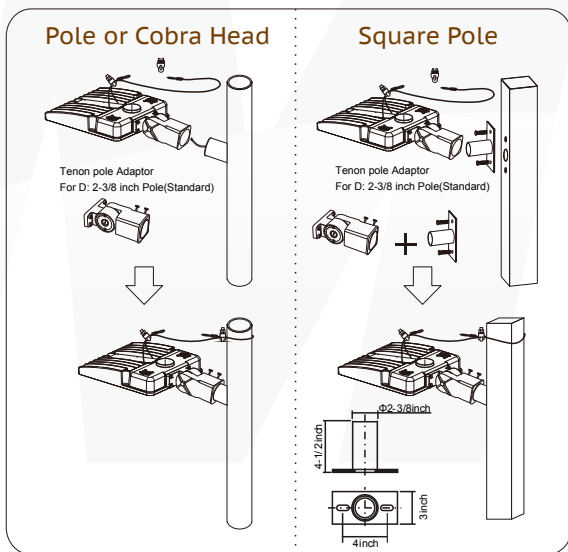

2.Trunnion

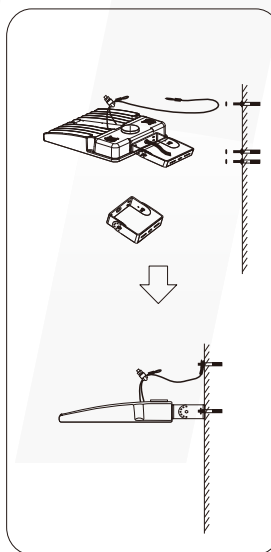

3.Arm

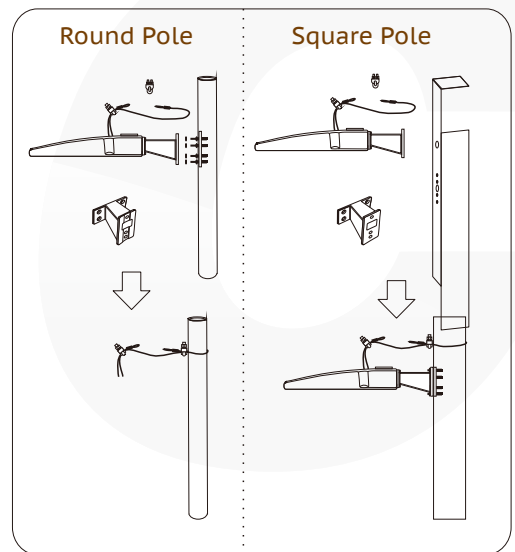

Packing box

Model	Carton size	Weight	Qty
MSL-D50/75-1	575* 257* 145mm	5.7/6.2kg	1pcs
MSL-D100/150-1	562* 345* 145mm	7.5/7.8kg	1pcs
MSL-D200-1	623* 345* 145mm	8.5kg	1pcs
MSL-D240/300-1	733* 360* 145mm	9.5/11kg	1pcs
MSL-D400-1	895* 360* 145mm	12kg	1pcs

